

PianoDisc

ProRecord

User guide

Ver. B0

Contents

Chapter 1	ProRecord Features	1
Chapter 2	Precautions	2
Chapter 3	Panel Description	3
Chapter 4	Getting Started	6
Chapter 5	Playing Back Demonstration Songs	7
Chapter 6	Selecting Instruments	8
Chapter 7	Metronome	1 2
Chapter 8	Recording and Playback	1 4
Chapter 8.1	Recording	1 4
Chapter 8.2	Playing Back Recorded Songs	1 5
Chapter 9	Setting Note Repeat Limits	1 7
Chapter10	Adjustments and Configurations	1 8
Chapter10.1	Tuning (Adjusting the Pitch)	1 9
Chapter10.2	Sensor Calibration	2 0
Chapter10.3	Automatic Sensor Calibration	2 1
Chapter10.4	Touch Control (Adjusting the Touch)	2 2
Chapter10.5	Pedal Positioning	2 3
Chapter10.6	Setting the Key Depth (note on/off)	2 4
Chapter10.7	Black Keys Volume Control	2 5
Chapter10.8	Volume Control for Individual Keys (Bass Keys)	2 6
Chapter10.9	Volume Control for Individual Keys (Treble Keys)	2 7
Chapter10.10	Returning Settings to Their Default Configuration	2 8
Chapter11	MIDI (Connecting to Other Device)	3 0
Chapter11.1	MIDI Implementation Chart	3 2
Chapter12	Specifications	3 3
Chapter13	Troubleshooting	3 4
Chapter14	Maintenance	3 6

Chapter 1 ProRecord Features

- ProRecord can detect a wide range of key positions (shallow to deep) therefore providing a the touch of an acoustic piano.
- Rapid trills and quick repeats of staccato notes are possible.
- ProRecord can be adjusted to match the touch of a particular piano by changing the force needed to produce the sound.
- ProRecord is capable of expressing a wide volume range from pianissimo to fortissimo.
- The damper pedal can be setup with either on/off or proportional output.
(Proportional pedal is not recommended when used with a player system)
- 8 instruments can be select from the control panel plus an additional 80 instruments from the piano keyboard.
- Built in Metronome function.
- Your performance can be recorded, and then played back. The tempo of the recorded data can also be changed.
- ProRecord can be connected to a computer using a USB cable or a MIDI cable. By connecting with a personal computer, this instrument can be used as a MIDI sound source or a MIDI keyboard.
- ProRecord can be connected to external audio devices using Line-out jacks.
- The maximum simultaneous polyphony is 108 notes.

Chapter 2 Precautions

Please observe the following precautions.

- Use only the proper AC adaptor to power ProRecord or use a compatible EXT connector to an external system.

NOTE: When the ProRecord is powered using the EXT connection, some functions are disabled

- Turn off the power before disconnecting the power cord from the control unit.
- If the system is not going to be used for a long period of time, unplug the AC adaptor.
- Do not use ProRecord in areas with high temperature or high humidity.

Chapter 3 Panel Description

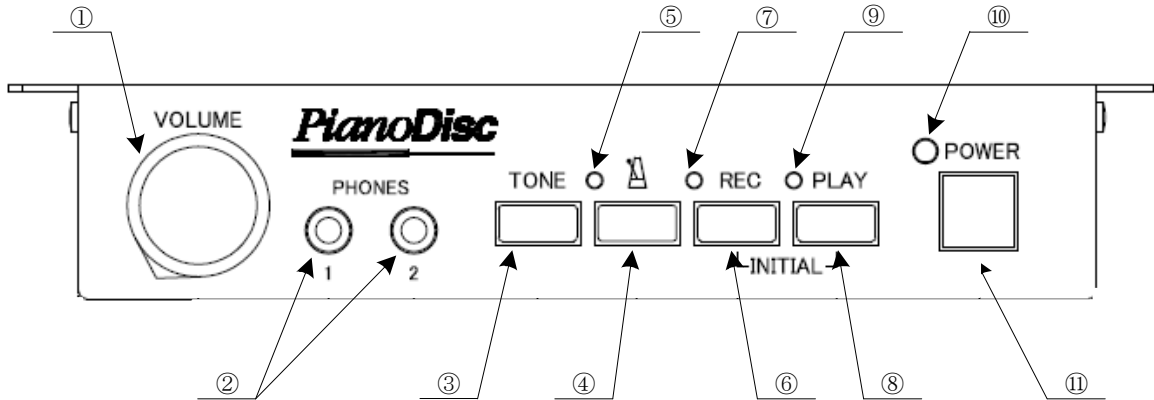

Control-BOX - Front Panel

① Volume Control (VOLUME)

Controls the volume of headphones and LINE OUT.

② Headphones Jacks (PHONES)

Connections for up to two stereo headphones.

③ Tone Select Button (TONE)

Selects the 8 main instruments as follows:

Piano, Bright Piano, Mellow Piano, Electric Piano1, FM Electric Piano
Church Organ, Warm Organ, Percussive Organ

④ Metronome Control Button ()

Controls the metronome functions, (start/stop and setup).

⑤ Metronome Status Display Lamp

Indicates when metronome is in use. (flashes when in setup mode)

⑥ Record Control Button (REC)

Controls start/stop of record function.

⑦ Record Status Display Lamp

Indicates when system is recording.

⑧ Playback Control Button (PLAY)

Controls start/stop of playback function.

⑨ Playback Status Display Lamp

Indicates when system is in playback mode.

⑩ Power Indicator Lamp

Indicates when power is tuned on. Flashes when keys and pedals are played. Also flashes the tempo of the metronome when used.

⑪ Power Switch

Used to turn the power on and off.

[Note]

Power should be turned off after each use.

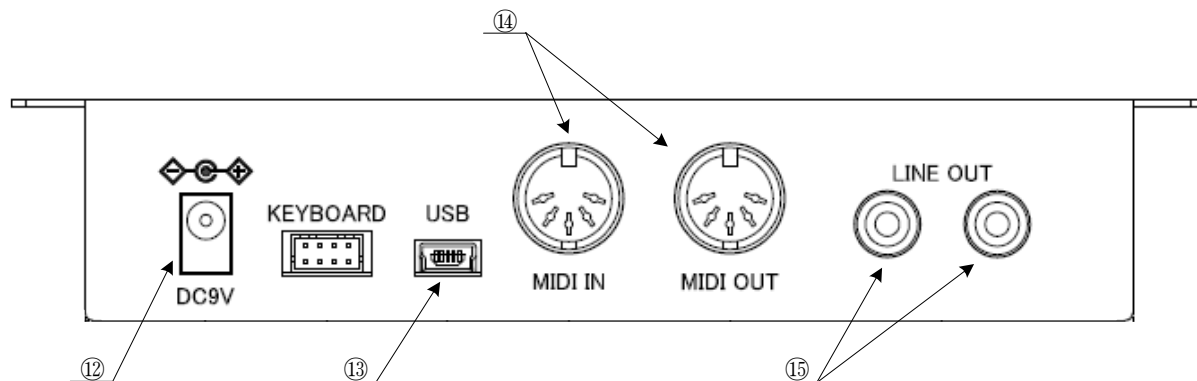

Control-BOX – Back Panel

⑫ DC Power Socket (DC9V)

For AC power adaptor.

[Caution!]

To avoid damage to the unit, use only AC adaptors of proper voltage. (9VDC out).

Note: If power is supplied from EXT connector (see item ⑯ below) do not connect AC adaptor.

⑬ USB mini B Jack (USB)

Used for connecting to a computer or other USB device.

⑭ MIDI Jacks (MIDI)

Used for connecting to an external MIDI device or computer.

⑮ RCA Jack (LINE OUT)

For connecting to an external stereo system.

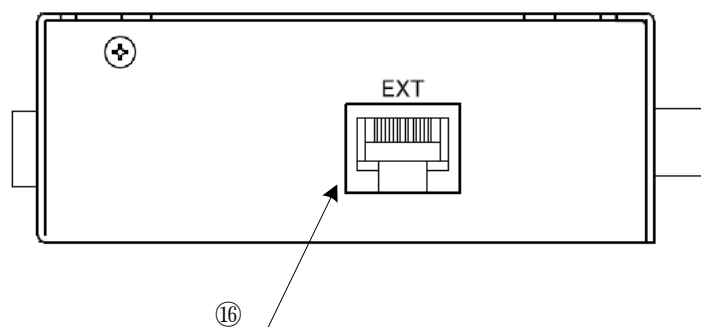

Control-BOX – RIGHT SIDE

⑩ External Connector (EXT)

For connecting to an external system. This connector contains a MIDI interface, and power input from a compatible external system.

NOTE: Using this connection will disable some functions.

Chapter 4 Getting Started

An initial setup procedure must be performed after installation before the system will operate correctly. This procedure should have been done by the person who initially installed the system.

- (1) Engage the mute rail (if equipped) to silence the acoustic piano.
- (2) Be sure the power is connected, either from an AC adapter or from a compatible external system.
- (3) Turn the power on by pressing the “POWER” button. Do not press any keys or pedals while powering on.
- (4) Plug the headphones into the PHONE socket.
- (5) Select the desired instrument using the “TONE” button.
- (6) Adjust the volume to a comfortable level.

Chapter 5 Playing Demonstration Songs

Ten demonstration songs are included in the control box. Refer to the chart below.

No.	Title	Composer
1	Prelude (Wohltempericrte Klavier I No.1)	Johann Sebastian Bach
2	Für Elise	Ludwing van Beethoven
3	Piano Sonate op.27-2 "Mondschein" 1st mov.	Ludwing van Beethoven
4	Shenandoah	American folk song
5	Danny boy	Ireland folk song
6	I love you, porgy	George Gershwin
7	Someday my prince will come	Frank Churchill
8	All the things you are	Jerome Kern
9	Someone to watch over me	George Gershwin
10	My wild irish rose	Chancellor Olcott

< To play demos >

- (1) Press the "PLAY" button for about 2 seconds. The "PLAY" lamp will start flashing.
- (2) When the "PLAY" lamp stops flashing, playback will begin starting with the first demo song and continue in order through all demo songs. To select another demo song, press "PLAY" and wait until the light starts to flash, then immediately press one of the white keys that corresponds to the song desired (see chart below).
- (3) To stop playback, push the "PLAY" button.

Left Side

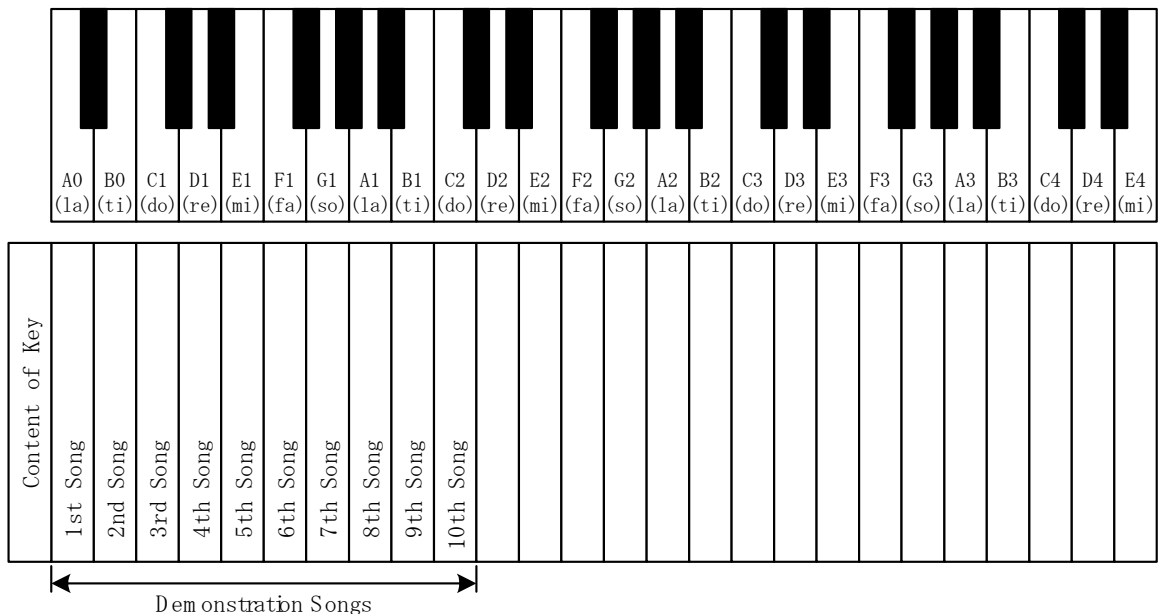

Chapter 6 Selecting Instruments

8 different instruments can be selected by pressing the “TONE” button on the control box. Each push of the “TONE” changes to the next instrument in sequence as follows:

Piano → Bright Piano → Mellow Piano → Electric Piano1 → FM Electric Piano
→ Church Organ → Warm Organ → Percussive Organ → (Back to the Piano)

A sample of each instrument will sound with each push of the “TONE” button.

88 different instruments can be selected using the “TONE” button in conjunction with the piano keys (including the 8 instruments listed above).

< Selecting one of the 88 instruments using the piano keys >

- (1) Push and hold the “TONE” button, then press one of the piano keys for the instrument desired. (See the keyboard chart on the following page.)
A sample of each instrument will sound with each key pressed.
- (2) Release the “TONE” button once you have selected an instrument.

[Note]

- If the power is turned off, the instrument will return to Piano.
- Some of the instruments have pre-set effects (such as chorus & reverb) as part of their default setting. In some cases, the effect may continue when a different instrument is selected, depending on the instrument selected.
- The rotary speaker effect is pre-set on the following instruments:

Warm Organ, Percussive Organ, Drawbar Organ 1, Drawbar Organ 2, Rock Organ

When these instruments are selected, the damper pedal acts as a switch which changes the speed of the rotary effect.

Instrument selections

*Piano 1 (normal)
*Piano 2 (bright)
*Piano 3 (Mellow)
Piano + strings
Piano 1 + choir
Bright Piano + Reverb
*Electric Piano 1
*FM Electric Piano
Harpsichord
*Church Organ
*Warm Organ
*Percussive Organ
Electric Piano2
Honk-tonk Piano
Pan Rhodes
Clavinet
Celesta
Glockenspiel
Music Box
Vibraphone
Santur
Drawbar Organ 1
Drawbar Organ 2
Rock Organ
Small Church Organ
Reed Organ
French Accordion
Harmonica
Bandoneon
Acoustic Guitar (nylon)
Acoustic Guitar (Steel)
Electric Guitar (jazz)
Chorus Guitar
Overdrive Guitar
Distortion Guitar
Acoustic Bass
Finger Electric Bass
Slap Bass
Synth Bass
Violin
Cello
Tremelo Strings
Harp
Strings

A0 B0 C1 D1 E1 F1 G1 A1 B1 C2 D2 E2 F2 G2 A2 B2 C3 D3 E3 F3 G3 A3 B3 C4 D4 E4

Bass end of keyboard

Instrument selections

Slow Strings
Strings + Horn
Synth Strings
Choir
Choir 2
Synth Voice
Trumpet
Trombone
Tuba
French Horn
Brass + Trumpet
Synth Brass 1
Synth Brass 2
Synth Brass 3
Synth Brass 4
Soprano Sax
Alfo Sax
Tenor Sax
Baritone Sax
English Horn
Bassoon
Clarinet
Piccolo
Flute
Recorder
Pan Flute
Ocarina
Synth Lead 2 (sawtooth)
Synth Lead 5 (charang)
Synth Lead 6 (voice)
Synth Lead 8 (bass + lead)
Synth Pad 2 (warm)
Synth Pad 3 (polysynth)
Synth Pad 4 (choir)
Synth Pad 5 (bowed)
Synth Pad 7 (hato)
FX 3 (crystal)
FX 4 (atmosphere)
FX 5 (brightness)
FX 7 (echo)
Sitar
Koto
Bagpipe
Steel Drums

F4 G4 A4 B4 C5 D5 E5 F5 G5 A5 B5 C6 D6 E6 F6 G6 A6 B6 C7 D7 E7 F7 G7 A7 B7 C8

Treble end of keyboard

NOTE: Instruments marked with an asterisk can also be selected with the "TONE" button alone.

Chapter 7 Metronome

Quiet Time has a built-in metronome function which can be setup with various parameters, such as beat, tempo, and volume.

< Metronome instructions, ON/OFF >

- (1) Press the metronome button to start the metronome. The metronome lamp will turn on and you will hear the metronome beating. Also, the "POWER" lamp will flash at the set tempo of the metronome.
- (2) Press the metronome button again to stop the metronome.

< Metronome Setup Instructions >

- (1) Press and hold the metronome button for about two seconds. The metronome lamp flash indicating that you are in the setup mode. The metronome will also begin to sound.
- (2) Choose beat. (Refer to the figure on the next page). The metronome can be set up with the following beat patterns:
0, 2, 3, 4, 5, 6, 8. Use the piano keys indicated to select the desired beat pattern.
- (3) Choose tempo. (Refer to the figure on the next page).
To set the tempo, enter the desired tempo using the lowest 10 white keys on the piano. It is necessary enter the tempo as a 3 digit number, so tempos less than 100 need to be preceded by a "0". (see the examples below). The allowable tempo range 30 to 250.

• example 1: To set tempo to 132.

↓
①Push A0 ("1")
↓
②Push C1 ("3")
↓
②Push B0 ("2")

• example2: To set tempo to 60.

↓
①Push C2 ("0")
↓
②Push F1 ("6")
↓
②Push C2 ("0")

- (4) Choose volume. (Refer to the figure on the next page).
- (5) Exit setup mode by pressing the metronome button. The metronome lamp changes from flash to solid. The metronome will continue to sound until the metronome button is press again.

[NOTE]

- The metronome settings are saved when power is turned off.



Bass End of Keyboard

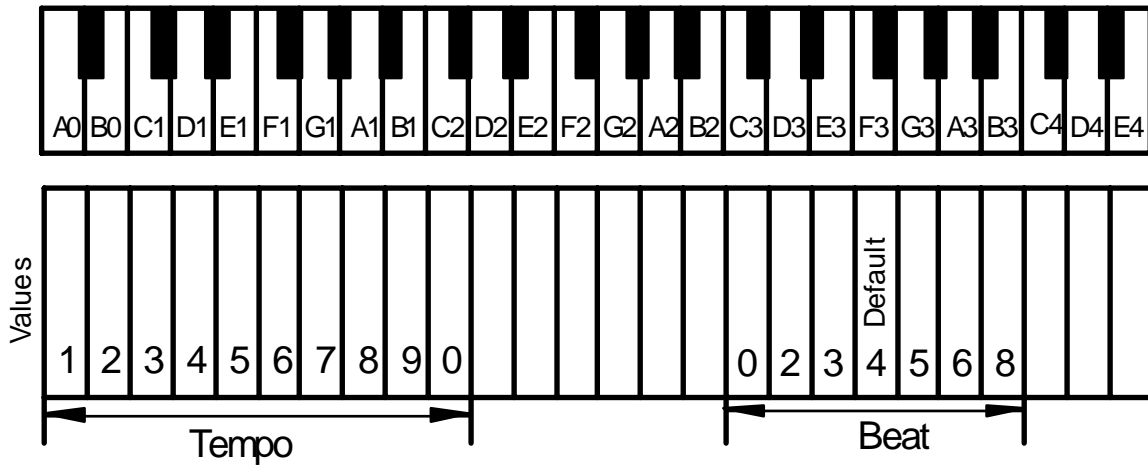

Treble End of Keyboard

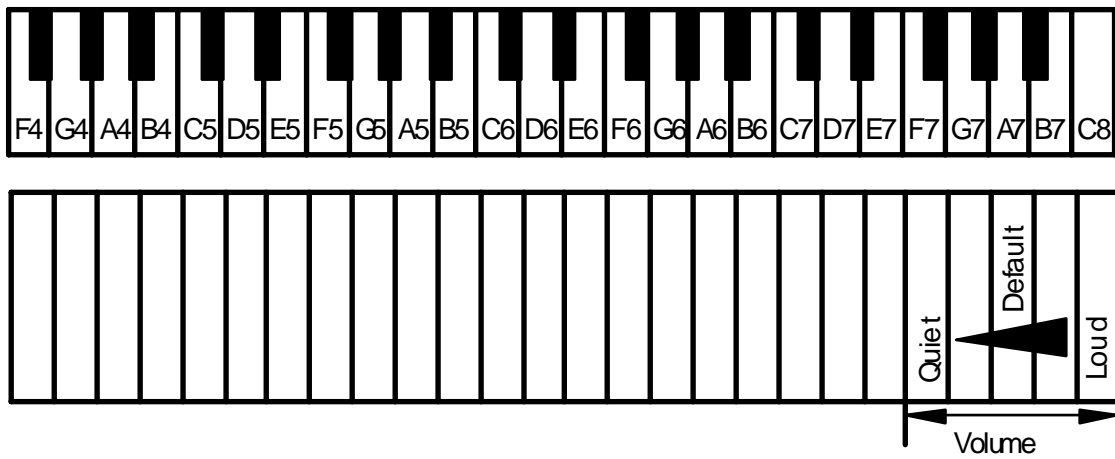

Chapter 8 Recording and Playback

QUIET TIME can record your piano performance and play it back at a later time. There are 10 banks that act as memory storage for the recorded song. The figure on the next page show which piano keys are used to access the storage banks.

Chapter 8.1 Recording

< Record Instructions >

(1) Press and hold the piano key for the bank you wish to record to. Then press the “REC” button. The “REC” lamp will light up to indicate that you are in the record mode.

Note : If you do not select a bank to record to, bank 1 will be selected by default.

(2) Recording will start when you play the first note or press a pedal.

(3) When you are finished, press the “REC” button. The “REC” lamp will turn off and data will be saved in the selected bank.

[NOTE]

- Recording to a bank that already has data will cause the previously stored data to be overwritten.
- Any instrument can be setup to record. However it cannot be changed during the recording.
- The Metronome can be used during recording but the sound is not recorded.
- Each bank can store about 10,000 key or pedal strokes. Once this limit is reached, recording will be stopped automatically.
- The recorded data is saved when power is turned off.

< To Delete a Recorded Song >

(1) Press and hold the sustain pedal, then press and hold the “REC” button.

(2) Press the piano key for the bank you wish to delete (see the figure on the next page). A chime will sound confirming that the data has been deleted. Performing a System Default (see Chapter 11.10) deletes any data stored in all 10 banks.

Chapter 8.2 Playing Back Recorded Songs

< Playback Instructions >

- (1) Press the “PLAY” button. The “PLAY” lamp turns on to confirm that Quiet Time is in play mode. The recorded song in bank 1 will begin to play about 1 second later.
- (2) To select a different bank, press the piano key for the bank desired. You can also play the piano during playback.
- (3) To stop the playback, press the “PLAY” button. The “PLAY” lamp will turn off and playback stops.

[Note]

- The first 10 white keys of the piano are assigned to bank selection during playback. Therefore they will not sound if you play along with the recording. If they are pressed during playback, a different bank will be selected for playback. Likewise, the last three white keys of the piano are assigned to tempo change functions during playback and will not sound.
- Playback will not start if there is no data in bank 1. If there is data in any of the other banks, Press and hold the bank you want to play, and then press the “PLAY” button.

Bass End of Keyboard

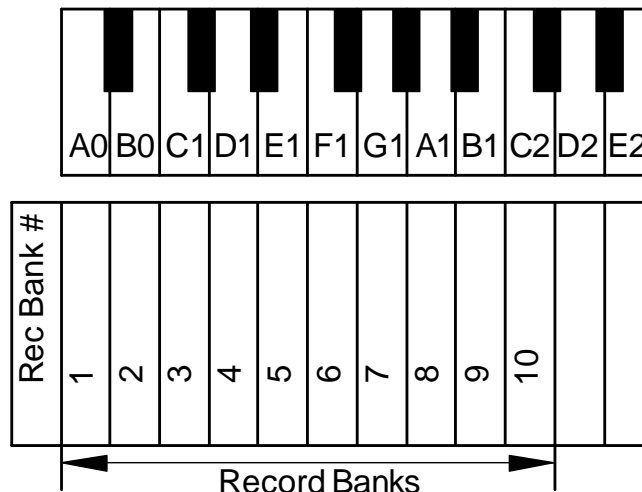

Changing the tempo of a recorded song.

The tempo of a recorded song can be changed during playback. The range of adjustment is from 0.5 times to 2.0 times the normal tempo (see chart below).

Step	- 5	- 4	- 3	- 2	- 1	± 0	+ 1	+ 2	+ 3	+ 4	+ 5		
Speed	0.5	0.6	0.7	0.8	0.9	1.0	1.2	1.4	1.6	1.8	2.0		
	Slow	←					Normal	→					Fast

< Tempo Instructions >

(1) Select a bank that has recorded data and play it back as described above (see <Playback Instructions>).

(2) Press one of the piano keys that control tempo (Refer to the following figure.) A7 decreases the tempo and C8 increases the tempo in 5 steps either direction from normal. B7 returns the tempo to normal.

NOTE: The tempo function is disabled when using the EXT connection.

Treble End of Keyboard

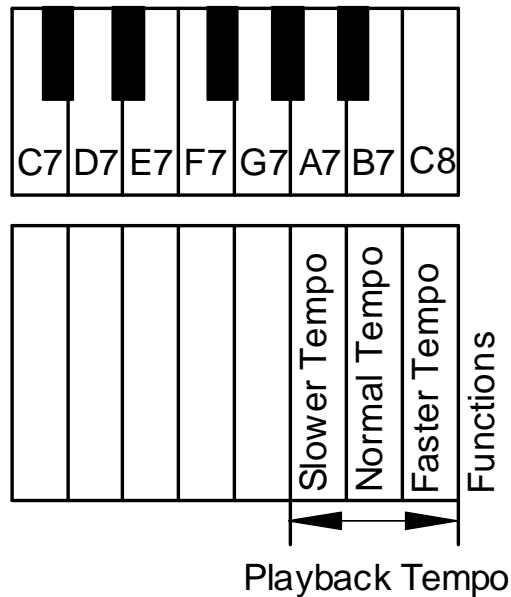

Chapter 9 Setting Note Repeat Limit

ProRecord can be set up with limits to how many times a note can be repeated per second.

< Setup Instructions >

- (1) Press and hold A#0 and G1 while turning the power on (refer to the figure below). If a MIDI device is connected, a MIDI signal will sound confirming that the system is in setup mode. Continue holding the two piano keys.
- (2) Select the repeat limit desired from the keyboard (see figure below).
- (3) Release the two piano keys to store your setting and to exit setup mode.

[Caution!]

Choosing a re-strike limit that exceeds the pianos capability may cause undesirable effects.

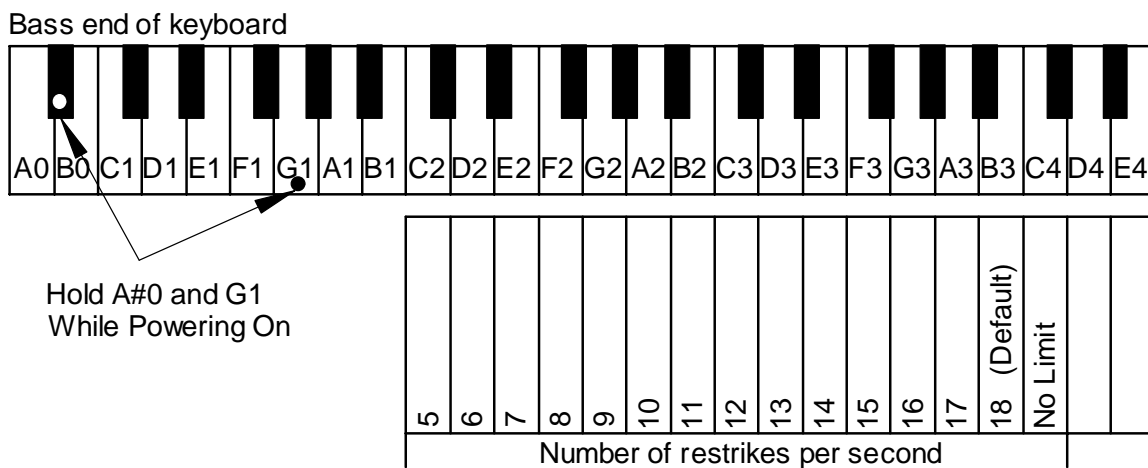

Chapter 10 Adjustments and Configurations

ProRecord can be setup to suit your preference.

[Caution!]

The installer should perform the initial setup procedure after the installation has been completed. If the system is reset to factory default (see section 8.9), all settings will be lost and the initial setup procedure must be performed again before the system will work properly.

Chapter 10.1 Tuning (Adjusting the Pitch)

The pitch of this instrument is set at A4=440 Hz. You can fine-tune the pitch up or down in 0.5 Hz steps. The maximum adjustment either direction is 13 Hz.

< Tuning Instructions >

- (1) Press and hold keys A#0 and C#1 while turning the power on. A chime will sound confirming that you are in the setup mode. Continue holding the two keys.
- (2) To lower the pitch, press G4 repeatedly until the desired pitch is established. To raise the pitch, press B4 repeatedly until the desired pitch is established. To return to A-440, press A4.

B4 raises pitch by about +0.5 Hz per step (maximum of +13 Hz).

G4 lowers pitch by about -0.5 Hz per step (maximum of -13 Hz).

- (3) Release the two keys to save your setting and exit setup. Setting will be retained when the unit is powered off.

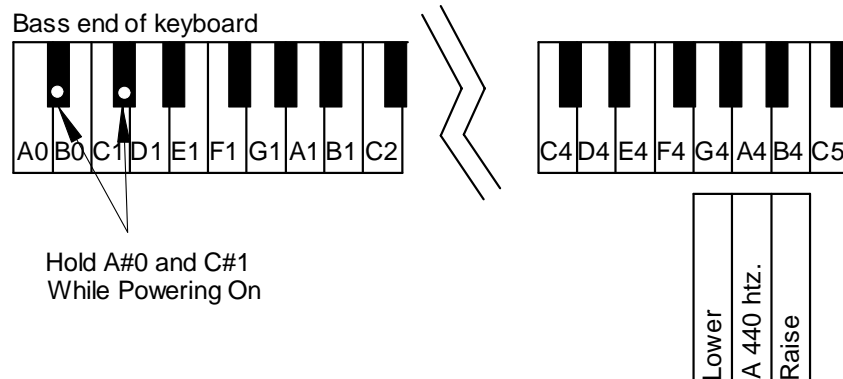

Chapter 10.2 Sensor Calibration

The sensitivity of the keyboard and pedal sensors can change with time and/or temperature. Periodic adjustments are required to keep your system operating at its optimum performance.

< Calibration Instructions >

- (1) Press and hold the “PLAY” and “REC” while turning the power on. A chime will sound to confirm that the system is in calibration mode, and the “PLAY” and “REC” lamps will flash alternately.
- (2) Press and release any key or keys that need to be re-calibrated. Be sure to press the key(s) to full depth and use the same force for all keys. A note will sound slightly delayed indicating that the key was re-calibrated. If no note is heard, it did not need calibration. It is not necessary to play each key. Only those that need re-calibration.
- (3) Press and release any pedal that needs to be re-calibrated. Be sure and press the pedal to its full depth. A chime will sound indicating that the pedal was re-calibrated. If no chime was heard, it did not need re-calibration. It is only necessary to press the pedal(s) that needs re-calibration.
- (4) Press the “PLAY” button. If the calibration procedure was successful, a chime will sound and the “PLAY” and “REC” lamps will stop flashing.

[Note]

If the system is powered off before the “PLAY” button is pressed, the calibration procedure will not be completed and must be done again.

Chapter 10.3 Automatic Sensor Calibration

ProRecord has the capability of calibrating the key and pedal sensors automatically. This function is enabled by default but can be disabled if desired.

< To Disable Automatic Sensor Calibration >

Press and hold keys B0 and D#1 while turning the power on. A MIDI signal will sound indicating that the automatic sensor calibration function has been disabled (see figure below).

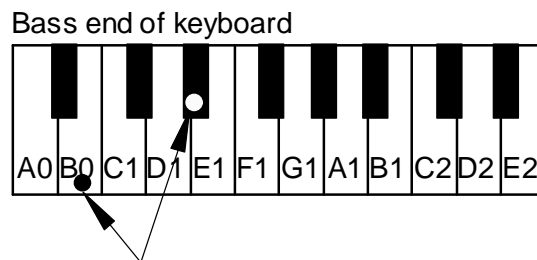

Hold B0 and D#1 While Powering On
To Turn Auto Calibration Off

< To Enable Automatic Sensor Calibration >

Press and hold keys B0 and D1 while turning the power on. A MIDI signal will sound indicating that the automatic sensor calibration function has been enabled (see figure below).

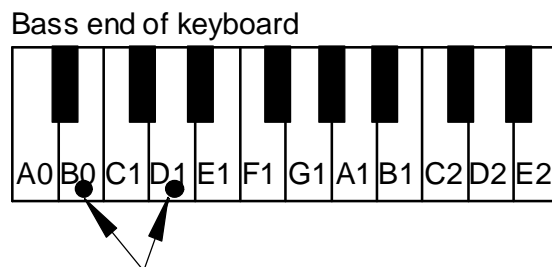

Hold B0 and D1 While Powering On
To Turn Auto Calibration On

Chapter 10.4 Touch Control (Adjusting the Touch)

ProRecord has the capability of changing the touch control of the keyboard (lighter or heavier). While it does not actually change the touch of the piano action, it can give the impression that the action is lighter or heavier. The idea is to match the feel of your piano. A heavier action would use a setting of 1 or 2 and a lighter action would be set to 7 or 8. The factory default for Touch Control is based on a Yamaha U3.

< Touch Control Instructions >

- (1) Press and hold down keys A#0 and B1 (see figure below) while turning the power on. You will hear a MIDI signal that confirms that the system is in the setup mode. Continue holding the two keys.
- (2) Select the desired touch control setting. (Refer to the figure below). Here are some typical settings:
YAMAHA : 3 ~ 5
KAWAI : 2 ~ 3
- (3) Release the two keys to store your setting and to exit setup. The setting is retained when the power is turned off.

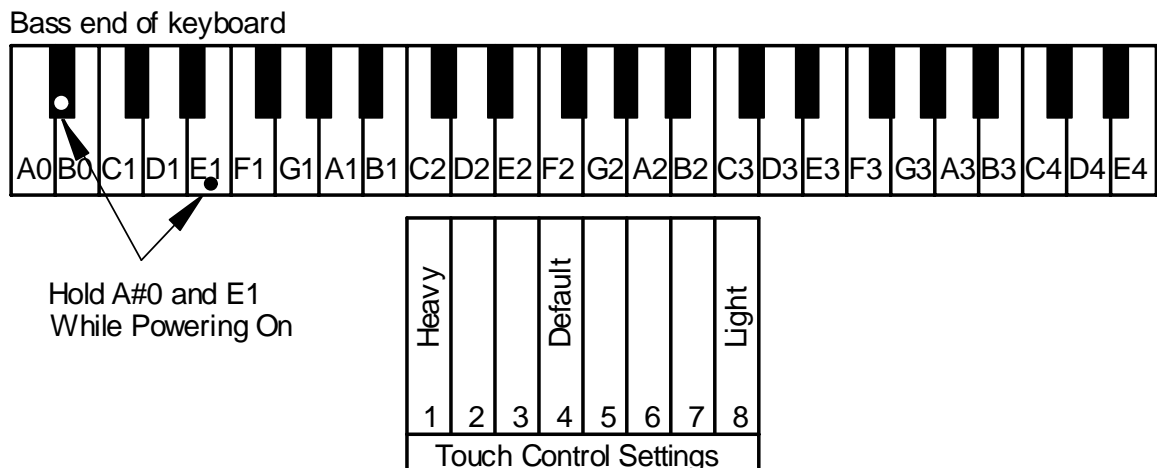

Chapter 10.5 Pedal Positioning

ProRecord allows you to set the depth to which the pedal function turns on. You can also enable a proportional pedal function for the sustain pedal if desired.

Note: Proportional pedal is not recommended for use with a piano player system.

< Pedal Positioning Instructions > (refer to the figure below)

- (1) Press and hold A#0 and B0 while turning the power on. A chime will sound to confirm that you are in pedal setup mode. Continue holding the two piano keys.
- (2) Press the pedal you wish to set to the depth which you want it to turn on. Hold the pedal at this position.
- (3) Press the “PLAY” button. A chime will sound indicating that the pedal “ON” position has been set.
- (4) Release the two piano keys.
- (5) To enable or disable proportional damper pedal, Press and hold A#0 and B0. Then press C2 for proportional pedal or B1 for ON/OFF pedal. Release the two piano keys to exit setup mode.

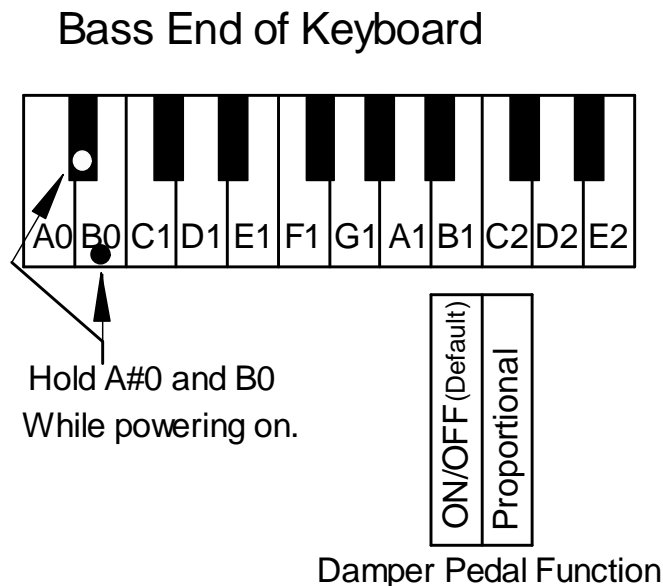

Chapter 10.6 Setting Key Depth for Note-on and Enabling / Disabling Contiguous Note-on

< Key depth instructions > (refer to the figure below)

- (1) Press and hold A#0 and D#1 while turning the power on. A MIDI signal will sound confirming that you are in the setup mode. Continue holding the two keys.
- (2) Using keys C2 – F2, select the depth desired for the note to turn on. Minus 2 & minus 1 will cause the note to turn on earlier in the key travel while plus 1 causes the note to turn on later. (Refer to the following figure.)
- (3) Release the two keys to save your setting and exit setup.

< Continuous note-on instructions > (Refer to figure below)

- (1) Press and hold A#0 and D#1 while turning the power on. A MIDI signal will sound confirming that you are in the setup mode. Continue holding the two keys.
- (2) Select Enabled or Disable (Refer to the following figure.)
- (3) Release the two keys to save your setting and exit setup.

Bass end of keyboard

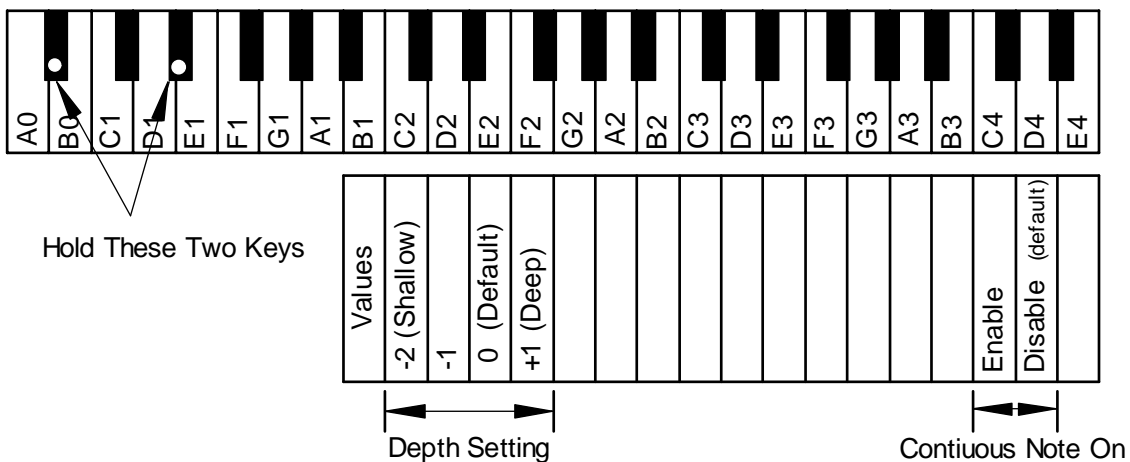

Chapter 10.7 Black Keys Volume Control

If the volume of the black keys is different than the white keys, they can be adjusted to match. (refer to the figure below)

< Black Key Volume instructions >

- (1) Press and hold A#0 and F#1 while turning the power on. A chime will sound confirming that you are in the setup mode. Continue holding the two keys.
- (2) Select the volume level that best matches the white key volume. (Refer to the following figure.)
- (3) Release the two keys to save your setting and exit setup mode.

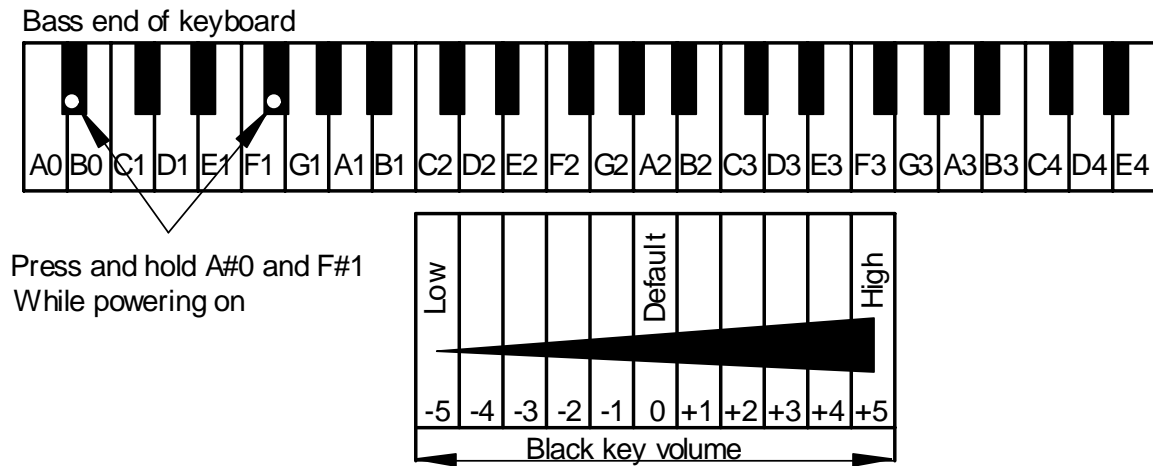

Chapter 10.8 Volume Control for Individual Keys (Bass Keys)

The volume level for individual keys can be adjusted in order to get even volume from note to note. The lower half of the keyboard must be done separately from the upper half.

The range of the adjustment is from -5 to +5. (default is ± 0)

< Volume Setting Instructions >

- (1) **To increase volume**, press and hold A#7 and G7 (see figure below) while turning the power on. A chime will sound to confirm that you are in the setup mode. Continue holding the two keys.
- (2) Select the note that needs to be adjusted from the lower half of the keyboard (A0 through E4) and press the key repeatedly until the desired volume is reached. Adjust other notes as needed.
- (3) Release the two keys to save the setting and exit setup mode.
- (4) **To decrease volume**, press and hold A#7 and F7 while turning on the power.
- (5) Repeat steps (2) and (3) above.

Left Side

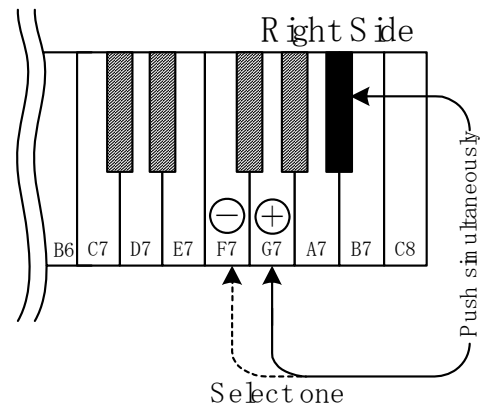
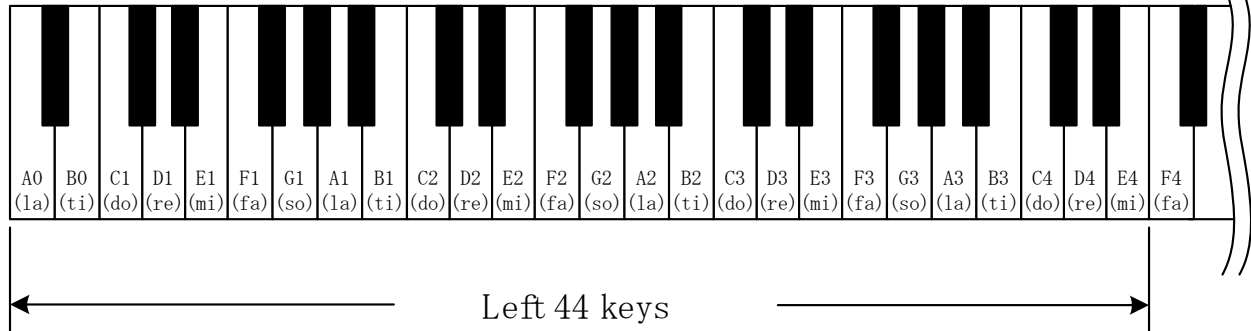

Chapter 10.9 Volume Control for Individual Keys (Treble Keys)

Volume adjustment for individual keys in the upper half of the keyboard (F4 through C8) is done in the same way as the lower half except that the setup keys are different (See figure below). In addition, there is a reset key which returns all values to the default setting of "0".

< Volume Setting Instructions >

- (1) **To increase volume**, press and hold keys A#0 and D1 while turning the power on.
- (2) **To decrease volume**, press and hold keys A#0 and C1 while powering on.
- (3) Select the notes that need to be adjusted in the upper half of the keyboard.
- (4) **To reset all values to "0"**, press and hold keys A#0 and F1 while turning on the power.
- (5) Release the two keys to save your settings and to exit setup mode.

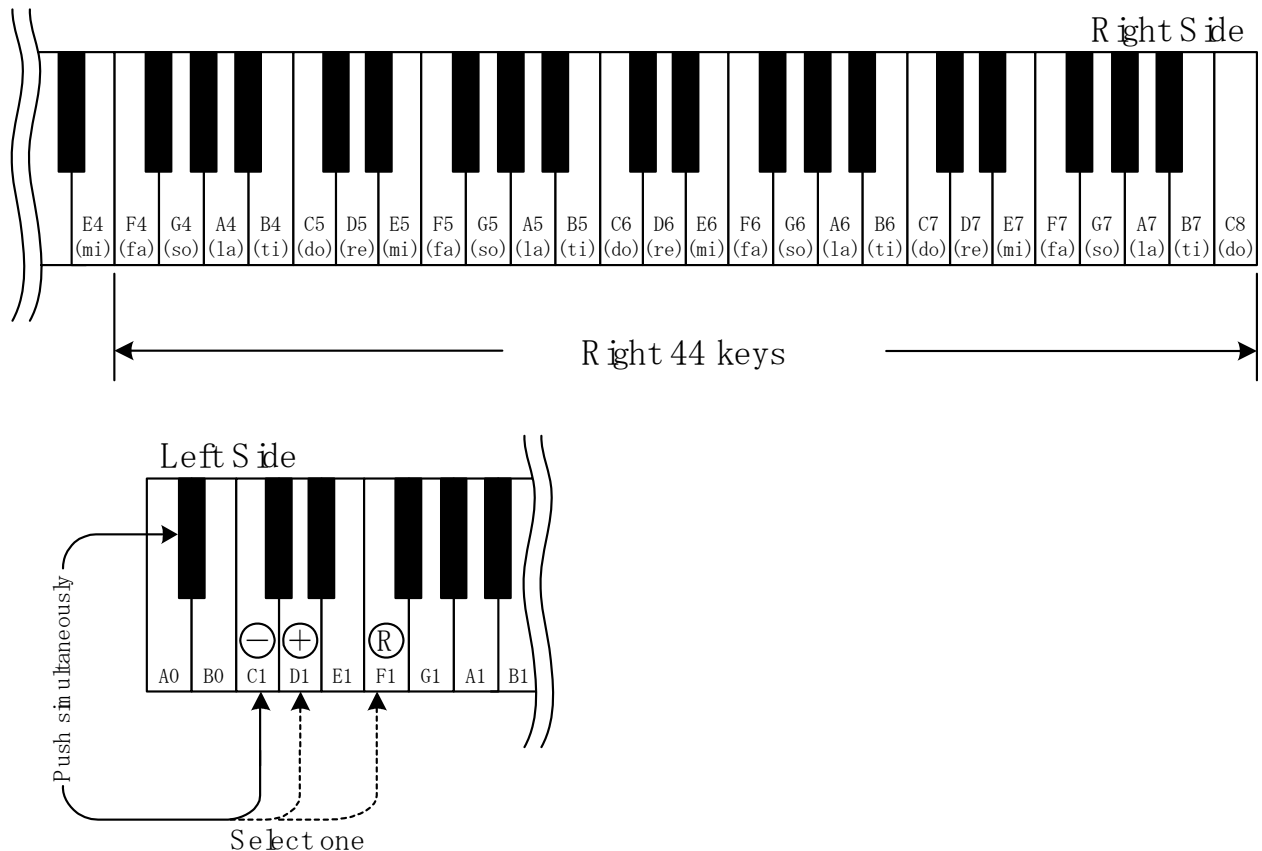

Chapter 10.10 Returning Settings to their Default Configuration

[Caution!]

When this process is performed, ProRecord will cease to operate normally. An initial setup is required in order to continue using. The initial setup procedure is outlined on the next page.

The following charts show the default settings:

Default Configuration	
Recorded song :	All Deleted
Number of Re-strikes Per Second :	18
Initial Setting :	Clear
Sensor Calibration :	Clear
Sensor Automatic Calibration :	ON
Touch Control :	4
Pedal Positioning :	Clear
Damper pedal function :	ON/OFF
Adjusting the Depth to Sound :	0
Continuous note-on MIDI commands :	disabled
Black Keys Volume Control :	0
Volume Control for Each Key :	All 88 keys = "0"

< Setting Default Configuration >

- (1) Press and hold A#0 and G#1 while turning the power on (see figure below). A MIDI signal will sound and the "PLAY" and "REC" lamps will flash alternately.
- (2) Release the two keys. The "PLAY" and "REC" lamps will stop flashing and the system as been reset to default values.

Bass end of keyboard

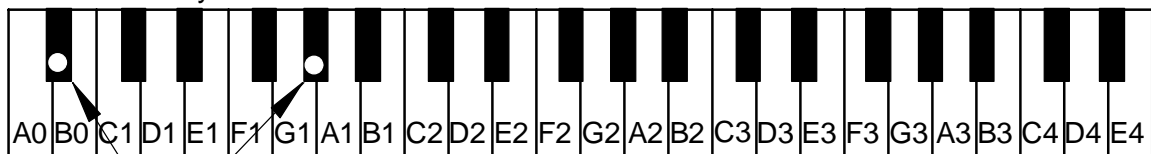

Hold A#0 and G#1 while powering on.

< Initial Setup Instructions >

- (1) Turn the power on. A chime will be heard and the “PLAY” and “REC” lamps will flash alternately indicating that the system is in “Initial Setup Mode”.
- (2) Play each note of the keyboard with equal force, making sure each key goes to full depth. When each note is release, the note will sound slightly delayed indicating that each key was calibrated.

Note: It may be helpful to pause a moment between each note to ensure that the note calibrates properly.
- (3) Press each pedal with equal force and full depth. A chime will sound after each pedal is press indicating that the pedal was calibrated. The chime for each pedal will be a different pitch.
- (4) Push the “PLAY” button. If the calibration of all keys and pedals was successful, a chime will be heard and the “PLAY” and “REC” lamps will stop flashing.
- (5) If any key or pedal did not calibrate properly, setup cannot be completed until the keys and/or pedals have be calibrated. The system will play the MIDI note of the keys or pedals that need to be calibrated. Play the keys or pedals again and then push “PLAY”.

[Note]

The Initial setup procedure will reset the touch control setting. Therefore, you must repeat the procedures outlined in section 8.3 to restore to your desired setting.

Chapter 11 MIDI(Connecting to Other Device)

ProRecord can be connected to a personal computer or MIDI device using the dedicated USB cable or MIDI interface cable.

- For Personal Computer : USB Cable
- For MIDI Device : MIDI interface Cable

(Connection with a personal computer)

If a personal computer is connected to your ProRecord, the information is transmitted to the computer as MIDI data. The MIDI data can then be edited and saved on the computers hard drive or other storage device.

(Connection with a MIDI device)

If a MIDI device is connected to your ProRecord, the information coming from ProRecord is transmitted to the MIDI device as MIDI data. The MIDI data can then be used by the MIDI device.

MIDI channel Specifications

ProRecord outputs data from the keyboard to the MIDI channel 1. Playback of the recorded data is output to the MIDI channel 2.

About MIDI

MIDI is an abbreviated name of Musical Instrument Digital Interface. The performance information on a musical instrument, the change information on a tone, etc. can be transmitted. It is a common protocol in the world.
--

Example of connection with a personal computer

Connect a personal computer with the USB miniB jack of the Control-BOX.
 Connection will install MIDI drivers automatically.

(Compliant OS : WindowsXP, WindowsVISTA, Windows7)

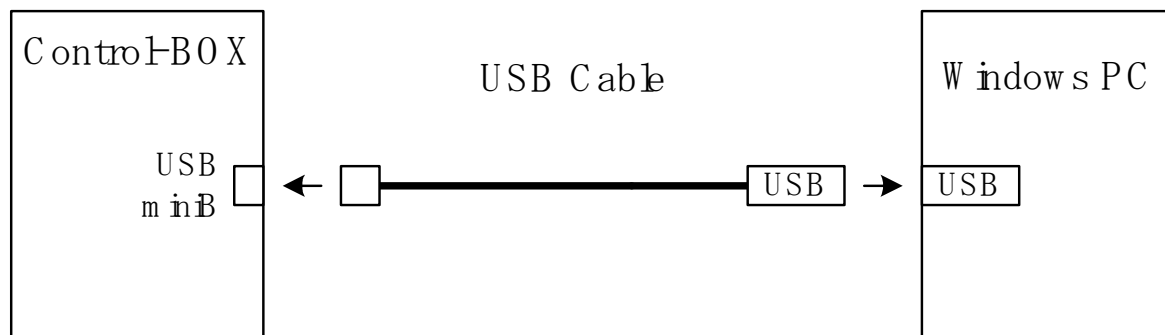

Example of connection with a MIDI device

Connect a MIDI device with the MIDI jack of the Control-BOX.

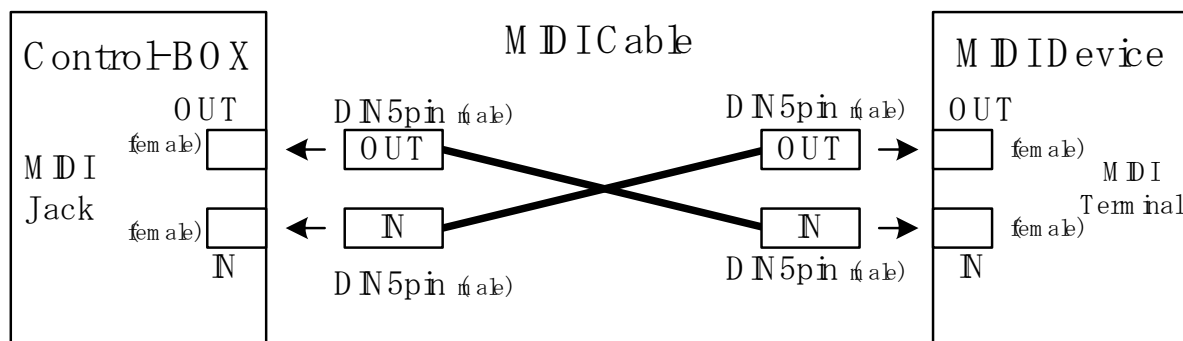

[Note]

MIDI and USB cables cannot be used simultaneously.

Chapter 12 Specifications

Polyphony	108-notes	
Instrument List	Piano, Bright Piano, Mellow Piano, Electric Piano1, FMElectric Piano, Church Organ, Warm Organ, Percussive Organ, etc... (can choose from 80 additional instruments)	
Metronome	Beat : OFF、2、3、4、5、6、8 Tempo : 30~250 Volume : 5 Level	
Record/Playback	Record : 10 Banks, Memory Size about 10,000 notes per Bank Playback : Variable Speed (0.5x~2x)	
Tuning	± 1.3 Hz (427~440~453 Hz)	
Pedal Positioning	ON/OFF、Proportional (Damper Pedal only)	
Number of Repeats Per Second	15 Step	
Setting Key Depth for Note-on	4 Step	
Touch Control	8 Step	
Continuous note-on	Enable / Disable	
Black Key Volume	± 5 Step	
Volume for Each Key	± 5 Step	
Demonstration Song	10	
Terminals	Analog	Headphones×2、LINE-OUT×1
	Digital	MIDI (IN/OUT)×1、USB×1
Power supply voltage	DC+9V (AC adaptor or supply from EXT IF)	
Accessories	Owner's manual (this book)	

●The specification and/or appearance of this product may be changed without prior notice.

Chapter 13 Troubleshooting

- **The unit turns on but does not play. And the “PLAY” and the “REC” lamps are blinking alternately.**
 - ProRecord is in initial setup mode. Complete initial setup as described in section 8.9 (page 20).
- **Power does not turn on.**
 - Check to see that the power cord is connected correctly? Insert the AC adaptor firmly into the DC9V socket and AC outlet.
 - Check for power at the AC outlet.
 - If the problem persists, contact an authorized repair source.
- **Some notes play louder or softer than others or not at all.**
 - It may be necessary to re-calibrate the system or adjust volume levels. See sections 8.1 to re-calibrate the system. If the black key volume does not match the white keys, see section 8.6. See sections 8.7 and 8.8 to adjust the volume on individual notes.
- **Pedal does not work, or is “stuck”.**
 - It may be necessary to re-calibrate the pedal sensors. See sections 8.1 and 8.4. If the problem persists, contact an authorized repair source.
- **The tempo of the metronome can’t be set up.**
 - Tempo must be set by inputting a 3 digit number using the piano keyboard. A tempo setting of less than 100 must be preceded by “0”. The allowable range is 30 to 250. Tempos less than 30 or more than 250 will not be recognized.